

*Kinga Boron*

Częstochowa University of Technology

al. Armii Krajowej 19, 42-200 Częstochowa, Poland, [boron.kinga@wip.pcz.pl](mailto:boron.kinga@wip.pcz.pl)**EVALUATION OF POROSITY OF ALZn5MG CASTINGS MADE BY SQUEEZE CASTING TECHNOLOGY****Abstract**

The paper shows the results of research aimed to assess the impact of high squeeze pressure on the porosity of AlZn5Mg alloy castings, including its distribution in slab-type castings with dimensions of 25 x 100 x 200 mm. The research was carried out on castings made by two methods: squeeze casting and gravity casting. The pressing was conducted at a pressure of 100 MPa at an initial mould temperature of 200°C. The research identified the middle and outer parts of the casting. Experimental research was preceded by numerical simulation of the casting solidification, then a porosity assessment was carried out using the hydrostatic weighing method, which was supplemented by structural observations. The results of the research showed a two-fold decrease in the porosity in the middle part of the casting which is most exposed to the occurrence of shrinkage voids formed in the final clotting phase. Structural tests revealed the occurrence of dispersed porosity in castings, mainly of shrinkage and / or shrinkage-gas origin. The impact of pressure of 100 MPa during solidification caused fragmentation of the primary structure of castings, which resulted in a higher grain density.

**Key words**

squeeze casting, AlZn5Mg, porosity

**Introduction**

Aluminum and zinc alloys have a chemical composition of from 5% to 14% zinc, as well as magnesium, copper, manganese, chromium and titanium. These alloys are called zinc durables and are characterized by the highest strength properties in comparison with other aluminum alloys. Tensile strength of Al-Zn alloys in precipitation-hardened state reaches 700 MPa, while yield strength 600 MPa, with relatively small elongation of 2 ÷ 5%. AlZn alloys are rarely used due to low resistance to elevated temperature and structural degradation, as well as low corrosion resistance, mainly stress corrosion. To increase the corrosion resistance of zinc durables, they are clad with pure aluminum. The advantage of aluminum alloys with zinc is their ease of welding and low ignition propensity, which makes AlZn alloy castings suitable for use with steel [1,2]. In contrast to other precipitation-hardened aluminum alloys, AlZn alloys are not sensitive to the cooling rate during supersaturation [3]. They can be hardened both cold and hot. During aging of Al Zn Mg alloys, metastable disperse phases are isolated in the following sequence [4]: supersaturated  $\alpha$  solution  $\rightarrow$  GP zones  $\rightarrow$   $\eta'$  phase  $\rightarrow$   $\eta$  ( $\text{MgZn}_2$ )  $\rightarrow$  T ( $(\text{AlZn})_{48}\text{Mg}_{32}$ ). GP zones in classic dural (Al-Cu) occur in the form of flat coherent discs, whereas in Al-Zn and Al-Zn-Mg alloys they usually take on a spherical shape [5-8]. Dispersive phase  $\eta'$  or GP zone particles provide high strength properties of castings at low temperatures and at 25°C. Characteristic properties of the AlZn5Mg alloy include sufficient castability, low resistance to hot cracking, poor tightness, very good machinability, good weldability, good polishability, good susceptibility to decorative anodising, very high strength (after precipitation hardening) at room temperature, low strength at elevated temperatures (above 100°C) and good plasticity. Despite the many advantages of this alloy, work is still in progress to increase its properties by using different casting methods and heat treatment. The presented research focuses on the use of the squeeze casting method. It is a method combining forging, pressure casting and die casting [9-11]. The combination of these three methods allows the production of products with many advantages such as fine grained structure, smooth surface or obtaining castings with high shape and dimensional precision. However, the main advantage of this method compared to pressure casting is the significant elimination of shrinkage and gas porosity and the possibility of heat treatment of castings [12].

**Research material and methodology**

For testing purposes, standardized (according to PN-EN 1676: 2002) AlZn5Mg aluminum alloy was used, from which slab-shaped castings were made. In order to identify potential spots of shrinkage porosity in the analyzed casting, experimental tests were carried out with a numerical simulation of solidification in NovaFlow&Solid software at initial conditions: mould temperature 200°C, temperature of the liquid alloy 720°C (entirely the

same), the material of the mould was made of carbon steel however, at the point of touch of the cast-mould the fourth type condition was adopted.

The metal charge was melted in the PIT50S / 400 crucible induction furnace. The castings were made on a PHM-250c hydraulic press (Figure 1) equipped with a metal mould with dimensions of 100x200x50mm recess and the ejector slab (Figure 2). Slab-shaped castings with dimensions of 100x200x25mm, were produced by the squeeze casting method and for comparison by the gravity method. Time of impact of the stamp on the casting of 60 seconds was based on preliminary research and literature data [12].



Figure 1. Hydraulic press  
Source: Author's



Figure 2. Mould cavity  
Source: [12]

The pressing process was carried out with the following parameters:

- mould temperature - 200°C,
- temperature of the metal charge - approx. 710°C
- squeezing pressure - 100 MPa
- time of impact of the stamp on the casting - 60 seconds.

Gravity casts were also made on a hydraulic press with the difference being that no pressure was applied, when the pressing ram was in the point of contact with a liquid alloy, the hydraulic system was turned off and the cast solidified without external pressure. Research was conducted on a total of 8 casts of the slab method, 4 gravity casts and 4 casts by direct compression. For the research on porosity, from each casting, 2 rectangular samples of 25x25x100 mm were taken. Samples were cut from the center of the slab (internal samples) and from its edges along the shorter side (external samples) (Figure 3) to analyze the porosity distribution in the cast. After taking porosity measurements, metallographic examinations were made and microstructural observations of the tested alloy were carried out.

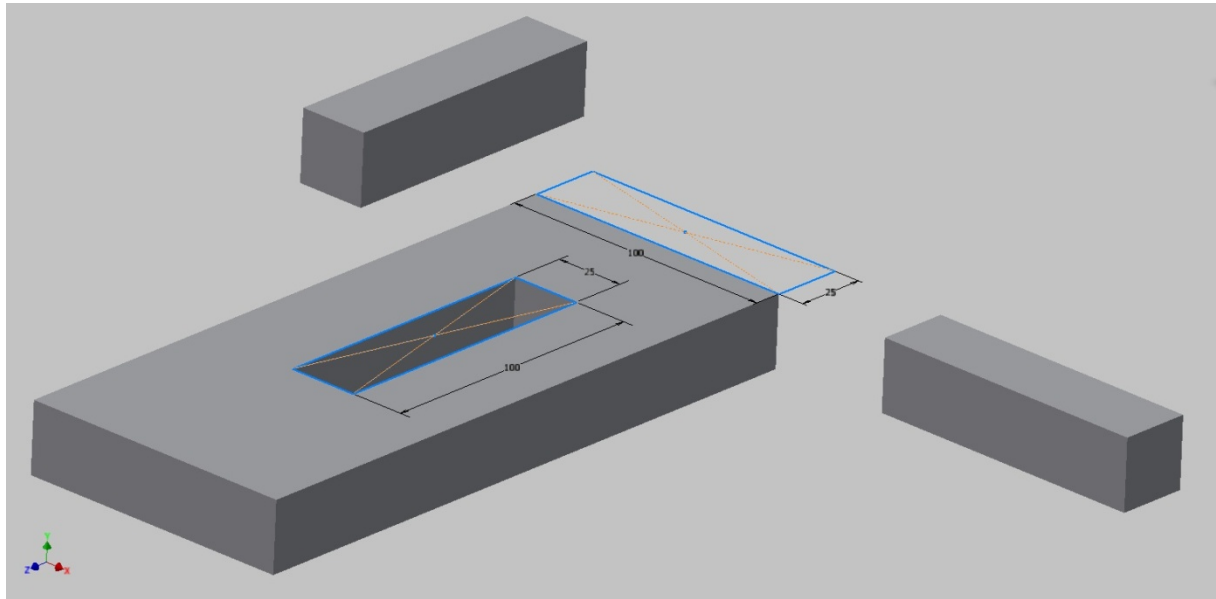

Figure 3. Scheme of cutting out samples from a casting slab  
Source: Author's

Evaluation of the porosity of the castings was carried out using the hydrostatic weighing method according to BN-75 / 4051-10 standard. Samples were weighed in air and water, and their density was determined from the following formula:

$$\rho_P = \frac{m_1}{m_1 - m_2} \cdot \rho_W \quad (1)$$

$\rho_P$  – sample density,  
 $m_1$  – weight of the sample in the air,  
 $m_2$  – weight of the sample in water,  
 $\rho_W$  – water density.

Then, the porosity of the tested samples was calculated:

$$P = (1 - LG) \cdot 100\% \quad (2)$$

LG – the gas number specified by the expression:

$$LG = \rho_P / \rho_{TS} \quad (3)$$

$\rho_{TS}$  – theoretical density of the alloy defined by the expression:  
 $A, B, N$  – content of individual components in% by mass  
 $\rho_{TA}, \rho_{TB}, \rho_{TN}$  – theoretical density of individual alloy components

The last point of the research was the observation and evaluation of microstructures. Observations were made on the samples prepared from the porosity measurement samples.

### Results and discussion

Numerical simulations of solidifications of the slab casting were carried out in the following conditions:

- mould temperature - 200°C,
- liquid alloy temperature - 720°C (homogenous for the entire cast),
- mould material - carbon steel.

At the point of touch of the cast-mould the fourth type condition was adopted. The thermophysical properties of the alloy and matrix were downloaded from the program NovaFlow&Solid database.

Number of unit cells 1,236,492. The characteristic size of the unit cell was 1.4 mm. The wall thickness of 25 mm was used for calculations.

On the basis of conducted numerical simulations of solidification (Figure 4-7), local thermal nodes were identified and potential places of shrinkage of porosity in the analyzed cast were determined.

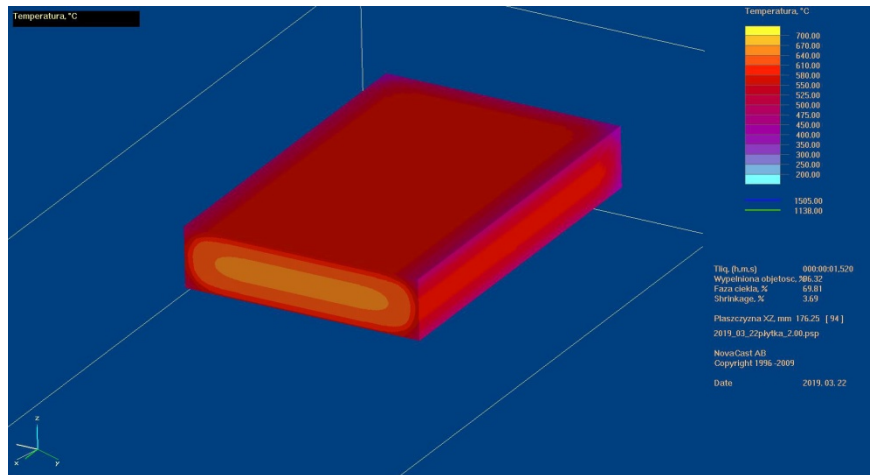

Figure 4. Area of liquid phase share in the middle period of solidification  
Source: Author's

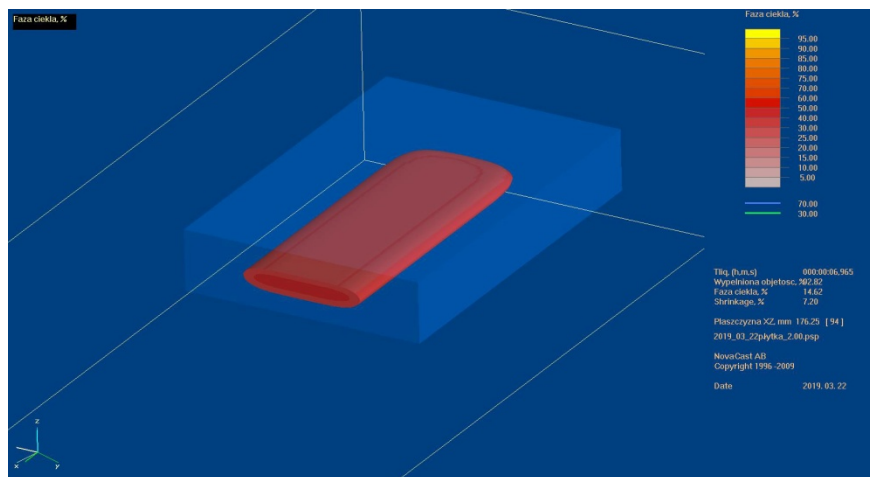

Figure 5. Area of liquid phase share in the final solidification phase - residual liquid  
Source: Author's

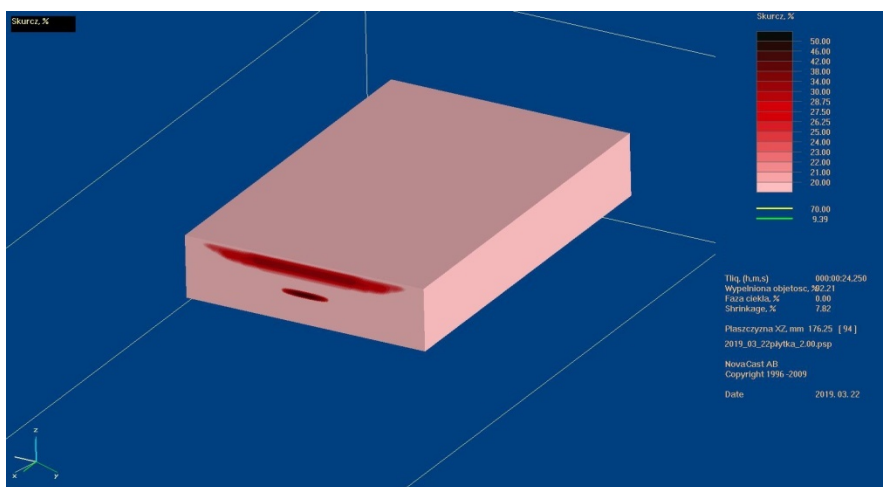

Figure 6. 3D distribution of the shrinkage in the cast after solidification  
Source: Author's

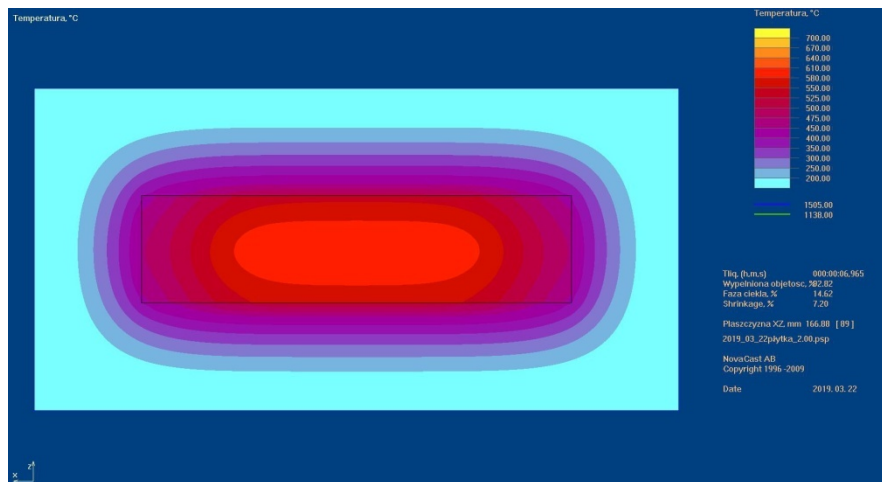

Figure 7. Temperature field in the slab casting and metal mould after solidification  
Source: Author's

The results of the solidification simulation showed that the cast solidifies the quickest on the edges, in the corners and on walls with a smaller surface area. From Figure 4, it can be observed that with a liquid phase of about 50%, the temperature in the central part of the cast was about 640°C, on the edges and walls about 580°C while the fastest heat dissipation comes from the corners where the temperature is around 450°C. The share of the liquid phase in the final phase of solidification, shown in Figure 5, is residual liquid which determines the area particularly exposed to shrinkage porosity. This area is the central part of the casting which gives off heat longest and solidifies last. The lack of liquid metal supply to this part of the casting results in the creation of a longitudinal void with dimensions of approx. 23 x 2.5 x 85 mm. Visualization of contraction effects in the center of the tested plate and in the area extending from the upper surface to the interior of the casting is presented in Figure 6. Considering the wide temperature range of solidification of the AlZn5Mg alloy, it should be assumed that diffused porosity will occur in these places. Numerical simulations also show that the total solidification time of the casting is 24.25 s, and the maximum temperature difference between the center and the edge of the plate is about 100°C. The matrix overheating zone up to 300°C in one casting production cycle is at the level of 150 mm. This area is the middle part of the cast, in which the heat dissipation time is longest and it solidifies last. The results of the solidification simulation, shown in Figures 5-7, reveal the occurrence of shrinkage effects in the central part of the tested slab and in the area extending from the upper surface to the center of the casting. Considering the wide temperature range of AlZn5Mg alloy solidification, it should be assumed that dispersed porosity will occur at these locations. The results obtained after the computer simulation were supported by the results of porosity tests and microscopic observations. The main conclusion which results from the conducted research, is the fact that the technology of squeeze casting reduces the porosity of the tested alloy two-fold in the middle part of the casting and in external areas the effects of compression were a reduction of porosity by approx. 0.3%.

The results of weight measurements of internal and external samples calculated on the basis of dependence (1) - (3) of actual density are summarized in Table 1. Figure 8 shows the average values of porosity in the specified parts of the slab, cast by gravity and squeeze casting methods.

Table 1. Testing results of the weight, density and porosity of internal and external casts by gravity and squeeze casting

Gravitational casting									
External samples					Internal samples				
Sample symbol	Weight in the air g	Weight in water g	Density g/cm <sup>3</sup>	Porosity %	Sample symbol	Weight in the air g	Weight in water g	Density g/cm <sup>3</sup>	Porosity %
4G_1Z	108.12	68.60	2.74	1.23	4G_1W	102.31	63.91	2.66	3.82
4G_2Z	105.45	66.82	2.73	1.45	4G_2W	116.45	73.26	2.70	2.67
4G_3Z	110.57	69.98	2.72	1.67	4G_3W	118.92	74.68	2.69	2.96

4G_4Z	112.56	71.29	2.73	1.53	4G_4W	107.56	67.16	2.66	3.89
Squeeze casting									
4P_1Z	116.80	74.13	2.74	1.18	4P_1W	107.89	68.36	2.73	1.48
4P_2Z	107.97	68.58	2.74	1.05	4P_2W	116.23	73.47	2.72	1.87
4P_3Z	107.56	68.28	2.74	1.14	4P_3W	106.81	67.68	2.73	1.47
4P_4Z	104.19	66.09	2.73	1.28	4P_4W	110.07	69.57	2.72	1.89

*Source: Author's*

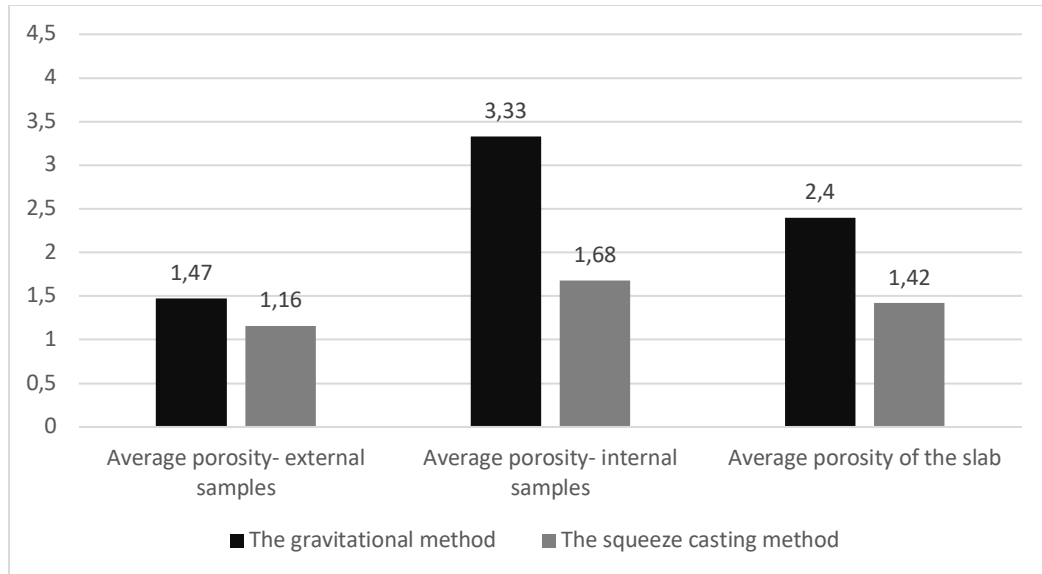

*Figure 8. Average porosity of the AlZn5Mg alloy casting*

*Source: Author's*

The graph clearly shows the average porosity in the entire slab area decreased significantly, in particular for internal samples where the porosity in the middle part decreased more than two-fold using the squeeze casting method. The obtained test results also confirm observations of the microstructure (Figure 9). In the case of gravity casts, around the primary crystals, visible interdendritic voids were created, while the squeeze casting method effectively lowered shrinkage microporosity and grain phase  $\alpha$  primary crystals.

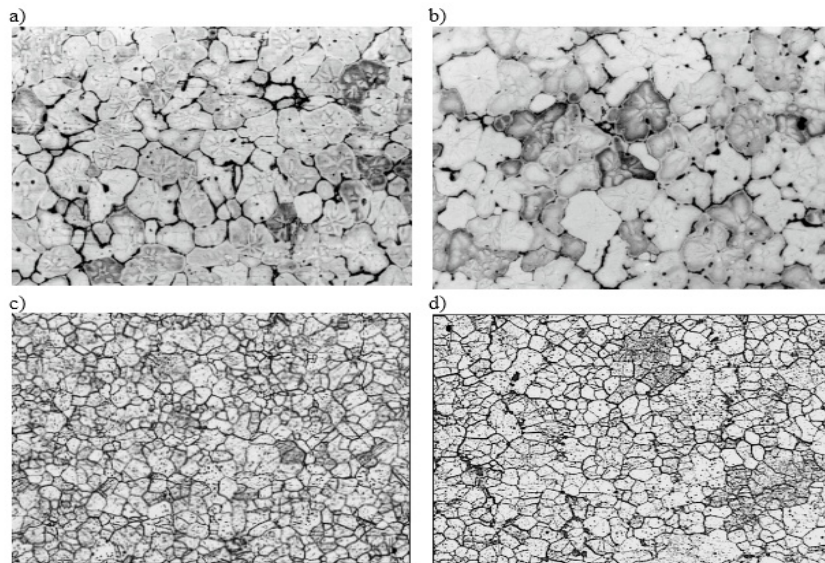

Figure 9. AlZn5Mg alloy structure, magnification 50x:  
 a) gravitational casting - edge of the slab  
 b) gravitational casting - the center of the slab,  
 c) squeeze casting - plate edge,  
 d) squeeze casting - the center of the slab  
 Source: Author's

Structural tests revealed the occurrence of dispersed porosity in castings, mainly of shrinkage and / or shrinkage-gas origin. The AlZn5Mg alloy shows a monophasic dendritic structure (where the morphology of crystallized crystals depends on the solidification conditions), while in the final solidification stage, in the middle part of the slab, due to the lack of liquid metal supply around the primary crystals, visible voids were created, and formed at the grain boundary in the tested alloy. In gravity castings, the primary phase crystallizes dendritically with only first-order branches with clearly rounded dendritic tips.

However, in squeeze casting the  $\alpha$  phase takes on a typically granular form. The pressing process also causes greater supercooling of the alloy, which in turn results in greater nucleation intensity [13,14] and very clear fragmentation of the grain structure of the alloy [Figure 9c, 9d]. In all the alloys tested, increased porosity was revealed on samples taken from the middle part of the slabs. When assessing the effect of pressure on solidification of the casting, it can be concluded that the grains are finely disintegrated, which is the result of faster heat dissipation during mould casting (no shrinkage gap) and a greater tendency of the alloys to nucleate the primary phases under high pressure conditions. The reduction in the shrinkage porosity of squeeze casting is primarily associated with their plastic flow in the liquid state as well as partly in the solid state as a result of local stress generated by the stamp [15]. It should also be noted that the phenomenon of plastic flow in the final phase of solidification and subsequent cooling of castings has a very positive effect on dimensional accuracy and shape mapping and surfaces of castings. A clear reduction of porosity in Al alloy castings produced by the squeeze casting method in comparison to gravity castings was also found in other studies [16]. It is believed that the very low porosity of pressed castings and the high level of primary graining favors the processes which occur during the hardening of the precipitated alloy and, as a result, obtains higher mechanical properties of squeeze casting casts in comparison to casts produced by gravity.

### Conclusions

On the basis of conducted tests of castings made of AlZn5Mg aluminum alloy produced by the squeeze casting method and gravity method, it can be stated that after numerical simulations of solidification of slab-type casting, it was observed that the area particularly exposed to shrinkage porosity is the middle part and area extending from its center to the upper surface. Due to the wide temperature range of solidification of the tested alloys, there is dispersed porosity in the casts, and the shape of the formed voids depends on the solidification morphology. Squeeze casting technology allows more than a two-fold reduction of porosity in the middle parts of the slab, while in the outer parts of the slab a reduction of 0.3%. The average porosity

of the castings for the whole slab made by squeeze method is more than twice less than that produced by gravity. The pressure impact of 100 MPa during solidification causes the fragmentation of the primary structure of the castings, which is manifested by a higher grain density.

#### References

- [1] M. Perzyk, *Odlewnictwo*, Wydanie II, Wydawnictwa Naukowo -Techniczne PWN-WNT (Foundry, 2nd Edition, PWN-WNT Scientific and Technical Publishing House), Warszawa, 2017
- [2] L. A. Dobrzański, *Podstawy nauki o materiałach i metaloznawstwo*, Wydawnictwo Naukowo – Techniczne (Fundamentals of materials and metal science, Scientific and Technical Publishing House), Warszawa, 2002
- [3] G.W. Lorimer, in: K.C. Russell, H.I. Aaronson (Eds.), *Precipitation Processes in Solids*, The Metallurgical Society of AIME, 1978, 87-119
- [4] D.R. Haefner, J.B. Cohen, *Acta Metallurgica* 40, 831, 1992
- [5] A. Zyska, Z. Konopka, M. Łągiewka, M. Nadolski, Heat treatment of squeezed AlZnMg alloy, *ARCHIVES of FOUNDRY ENGINEERING*, ISSN (1897-3310) Volume 8, 2008, 123-126
- [6] I.J. Polmear, *Light Alloys*, Journal of Metallurg and Materials Science, Series 3rd Edition, London 1995
- [7] L.F. Mondolfo, 1971, *International Materials Reviews* 153, 95, 1971
- [8] S.K. Maloney, K. Hono, I.J. Polmear, S.P. Ringer, *Scripta Metallurgica* 41, 1031, 1999
- [9] J. Sobczak, *Teoretyczne i praktyczne podstawy procesy prasowania w stanie ciekłym (squeeze casting) metali nieżelaznych (Theoretical and practical foundations of liquid state squeeze casting processes for non-ferrous metals)*, Prace Instytutu Odlewnictwa, Zeszyt Specjalny Nr 41, Kraków, 1993
- [10] M.R. Ghomashchi, A. Vikhrov, Squeeze casting: an overview, *Journal of Materials Processing Technology* 101, 2000
- [11] A. Zyska, Z. Konopka, M. Łągiewka, A. Bober, S. Nocuń, *Modyfikacja Stopu AlZn5Mg*, Archives of Foundry, Year 2006, Volume 6, № 22, *Archiwum Odlewnictwa*, Rocznik 6, Nr 22, 2006
- [12] A. Zyska, Z. Konopka, M. Łągiewka, M. Nadolski, Characteristics Of Squeeze Cast AlZn5Mg Alloy Castings, *ARCHIVES OF METALLURGY AND MATERIALS* Volume 55 Issue 3, 2010
- [13] E. Fraś, *Krystalizacja metali*, Wydawnictwo Naukowo – Techniczne (Metal crystallization, Scientific and Technical Publishing House), Warszawa, 2003
- [14] R. Haimann, *Metaloznawstwo, Część I*, Wydanie trzecie zmienione, Oficyna Wydawnicza Politechniki Wrocławskiej, Wrocław, 2000
- [15] A. Chérif, S. Souissi, M.B. Amar, C. Bradai, M. Khitouni, Effect of Squeeze Casting pressure on microstructure and mechanical properties of recycled aluminum alloy, *Journal of the Tunisian Chemical Society*, 19, 2017, 198-207
- [16] A. Zyska, Z. Konopka, M.Łągiewka, M. Nadolski, The influence of squeeze casting parameters on the mechanical properties of AlZn5Mg alloy, *Archives of Foundry Engineering* Volume 8, 2008, 347-350